



**Optical properties of Makrolon®
and Apec® for non-imaging optics**





1 Introduction	
A Nomenclature	03
B Color designation	03
2 Clear, transparent Makrolon® grades	04
A Transmission spectra	05
B Refractive index	07
C Weathering properties	08
D Temperature resistance	10
E Aging under artificial light sources	11
3 Signal colors	12
4 High-reflectance white	15
5 Special colors	16
A NIR-transparent black	16
B NIR-absorbing grades	16
C Laser-marking colors	16
6 Translucent grades	17
7 Apec® – High-temperature-resistant Polycarbonate	21
8 Appendix – Typical properties of Makrolon® and Apec®	24

1 Introduction

Makrolon® and Apec® polycarbonates from Covestro are characterized by a combination of crystal clear transparency, high heat resistance, high strength and good flame retardant properties. This brochure mainly describes the optical properties of Makrolon® and Apec®, and how they are affected by temperature and UV light. However, a brochure of this kind can only cover a limited selection of the diverse sets of requirements. In its polycarbonates portfolio, Covestro distinguishes optical Makrolon® grades and other specialty grades, such as the high-temperature polycarbonate Apec®, from the standard Makrolon® grades. This brochure focuses on the optical properties of the optical Makrolon® and Apec® grades.

A | Nomenclature

The following system of nomenclature is used for most Makrolon® and Apec® grades:

The designation of Makrolon® and Apec® sales products are based on a 4-digit, self-explanatory nomenclature.

Makrolon® LED	22	4	5
The first two digits denote the viscosity: 22 low viscosity 24 low viscosity 26 medium viscosity 28 medium viscosity 31 high viscosity			
Digit 3 differentiates between standard grades and special grades: 0 standard grade 1 or 4 special grade, often specified by a prefix, such as OD, LED, AL or LQ			
The fourth digit denotes additive package: 5 easy release 7 easy release, UV-stabilized			

Apec®	20	9	7
The first two digits denote the heat resistance: 16 Vicat approx. 160°C 17 Vicat approx. 170°C 18 Vicat approx. 185°C 20 Vicat approx. 203°C			
Digits 3 and 4 describe the grade: 95 easy-flowing, easy release 97 easy-flowing, UV-stabilized, easy release 03 grade with elevated viscosity, UV-stabilized			
The fourth digit denotes additive package: 5 easy release 7 easy release, UV-stabilized			

B | Color designation

The material designation is followed by a 6-digit color code. The first two digits indicate the main color, the other four digits serve to distinguish between different shades. The designation 000000 refers to a natural shade with no added color.

The following sections describe Makrolon®. Apec® is described in the last section.

	Opaque colors	Transparent colors	Translucent colors
White	01	–	02 (translucent white)
Yellow	10	15	12
Orange	20	25	22
Red	30	35	32
Violet	40	45	42
Blue	50	55	52
Green	60	65	62
Grey	70	75	72
Brown	80	85	82
Black	90	–	–

Tab. 1: Color designation of Makrolon® and Apec®

2 Clear, transparent Makrolon® grades

Covestro sells standard grades with and without UV protection and in various viscosities. The MVR ranges from 36 cm³/10 min for low-viscosity grades (Makrolon® 2205 550115 and Makrolon® 2207 550115) to 10 cm³/10 min for injection molding grades of medium viscosity (Makrolon® 2805 550115 and Makrolon® 2807 550115). For more information on high-viscosity grades, refer to the separate brochure on extrusion (Makrolon® ET-Resins for Extrusion and Thermoforming).

- Makrolon® OD2015 was developed specifically for the manufacture of optical data storage media. It is a high-flow grade available only in a natural color.
- Makrolon® LED2045 and LED2245 are both optimized for applications requiring high transmission for long optical paths (e.g. optical fibers) combined with high resistance to intense LED light. Availability of the two grades varies by region. They are both low-viscosity grades. Makrolon® LED2045 is available in natural color 000000 only. Makrolon® LED2245 is available in natural color 000000 and icecolor 550207.
- Makrolon® AL2447 and Makrolon® AL2647 are low-to-medium-viscosity specialty grades for headlamp covers. They are offered in the color 550396 (551070 NAFTA only). These grades display a slightly bluish tint that is very consistent from batch to batch. Together with various scratch-resistant coatings, they are approved under ECE and AMECA for automotive headlamps.

	General purpose grades					Special optical grades		
Grade	Makrolon® 2205/ 2207	Makrolon® 2405/ 2407	Makrolon® 2605/ 2607	Makrolon® 2805/ 2807	Makrolon® OD2015	Makrolon® LED2045/ LED2245**	Makrolon® LED2245	Makrolon® AL2447/ 2647
Color code	550115	550115	550115	550115	000000	000000	550207	550396/ 551070**
Color	Crystal clear	Crystal clear	Crystal clear	Crystal clear	Non-tinted	Non-tinted	Ice color	Crystal clear
MVR (cm³/10 min @300°C)*	36	19	12	10	61	61 36	36	19 12
Transmission Ty (4 mm)*	87–88%	87–88%	87–88%	87–88%	90%	90%	89%	88%
Application	General purpose grade	General purpose grade	General purpose grade	General purpose grade	Optical grade CD/DVD	Light guides, collimator optics	LED lenses	Head lamp lenses
UV-protected	no/yes	no/yes	no/yes	no/yes	no	no	no	yes

* typical value, no specification

** availability depends on region

Tab. 2: Basic properties of selected clear Makrolon® grades

Covestro also offers materials for medical technology and food contact applications, as well as for the corrective eyewear industry. Very high purity requirements are also fulfilled in these fields of application, although other

regulatory requirements have higher priority. For this reason, they are not discussed further here; refer to the corresponding brochures.

A | Transmission spectra

Makrolon® has high optical transmission in the visible range and in the near-infrared range to about 1100 nm. Makrolon® absorbs light in the UV range and in the infrared range > 1100 nm. Transmission spectra are shown below (Fig. 1).

In the case of clear, transparent grades, a distinction is made between different color formulations:

- The color "natural" refers to the color of the basic material without color correction. If viewed across an edge, for example, it appears to have a slightly yellow cast. The color code is 000000.
- A slightly bluish tint lends the material a fresher-looking color called "crystal clear." With the blue correction, some transmittance is lost, particularly in thick-walled articles. The most common color code is 550115.
- A special variation of "crystal clear" is "ice color," as in Makrolon® LED-2245 550207. Even in thick-walled articles, this material still displays high transmittance, although it is perceived as having a slightly bluish cast.

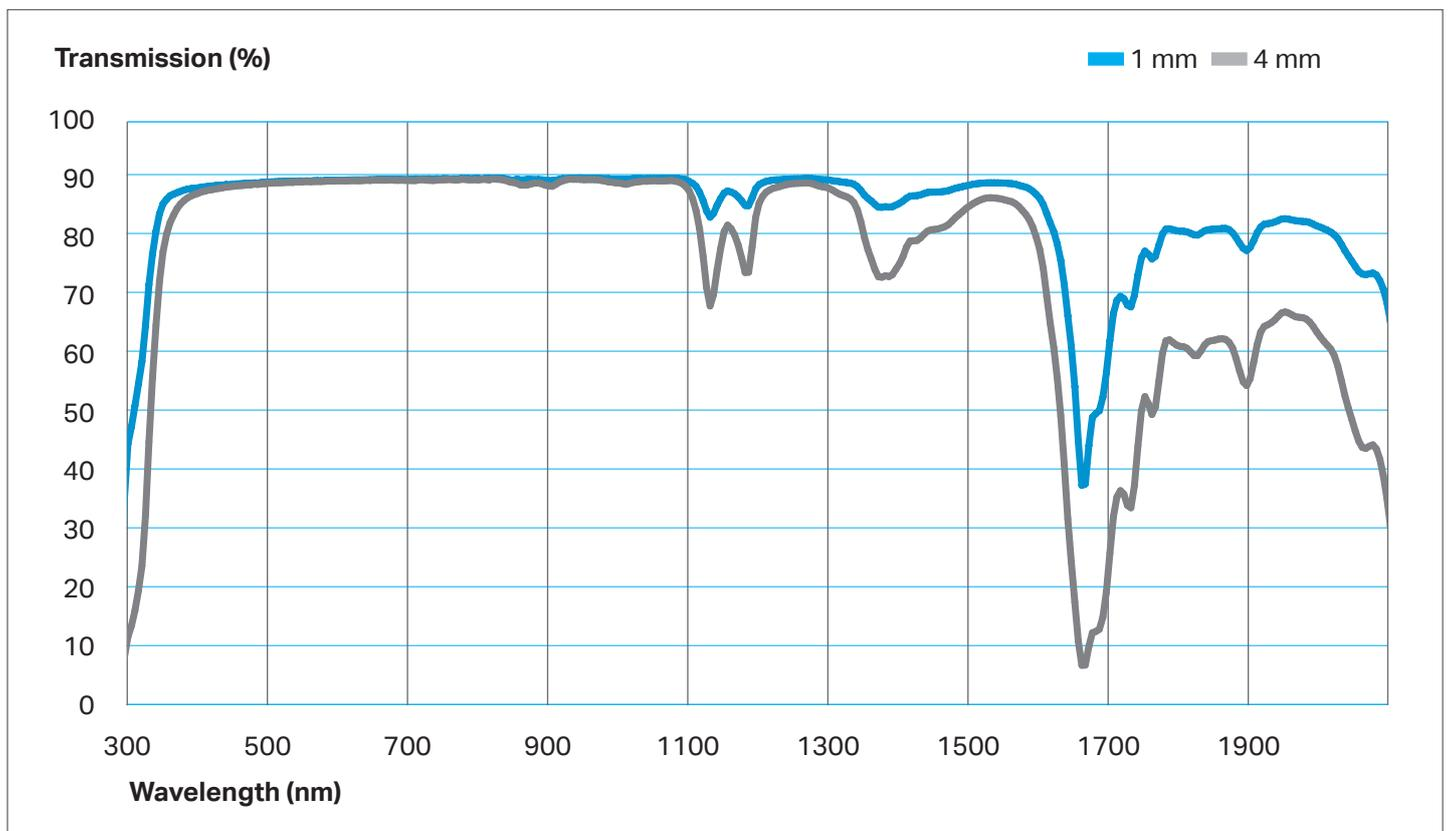

Fig. 1: Transmission spectra of Makrolon® OD2015 (1 mm and 4 mm)

The optical blue impression of “crystal clear” is preferred for standard injection moldings. In the case of long light paths, such as in thick-walled lenses or optical light guides, the inherent loss of transmittance in blue-tinted materials can be high, and processors should choose natural color or icecolor grade instead. This behavior is illustrated in Fig. 2. Please be aware that Makrolon® LED2045 000000 and Makrolon® LED2245 000000 show very similar transmission spectra and Ty properties (Fig. 2 + 3). Also Makrolon® AL2647 550396 shows very similar transmission spectra and Ty properties compared to Makrolon® AL2447 550396, Makrolon® AL2647 551070 and Makrolon® AL2447 551070.

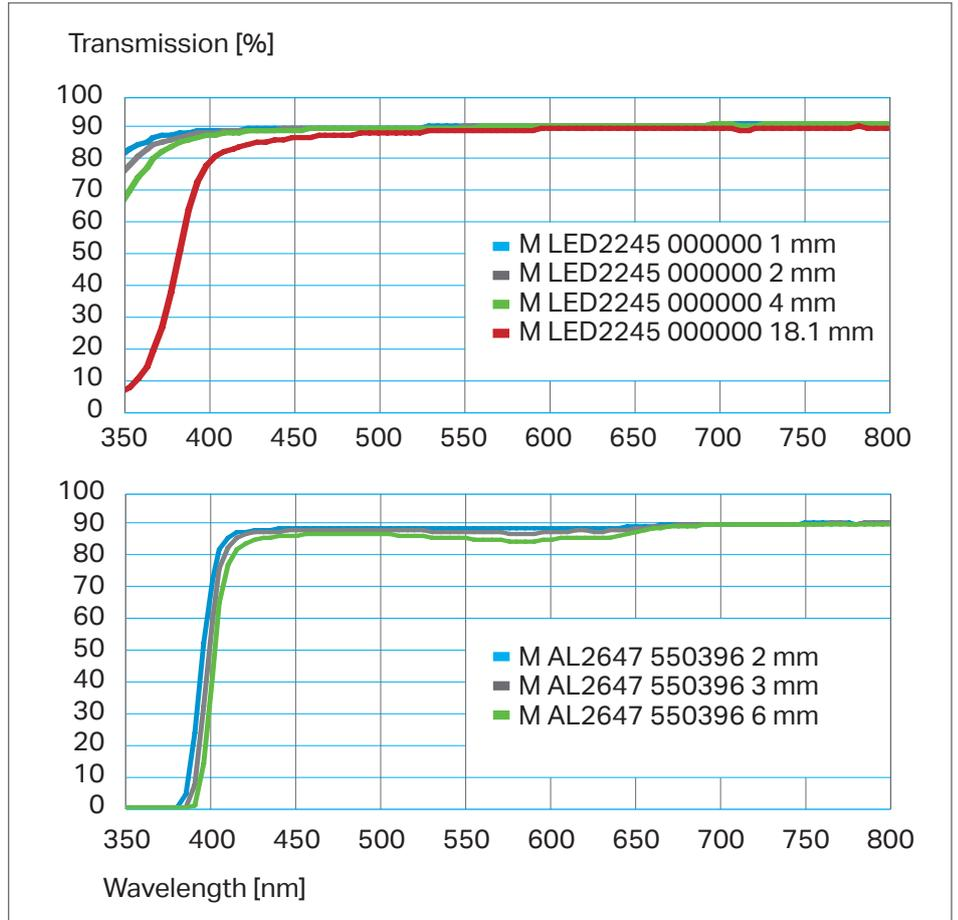

Fig. 2: Transmission spectra of Makrolon® LED2245 000000 and Makrolon® AL2647 550396 at various wall-thicknesses

The same behavior is observed if the compressed form of transmission Ty is selected instead of the wavelength dependent form of the transmission spectra as shown in Fig. 3.

Other color characterization methods include haze, the yellowness index, as well as the absolute and relative color coordinates.

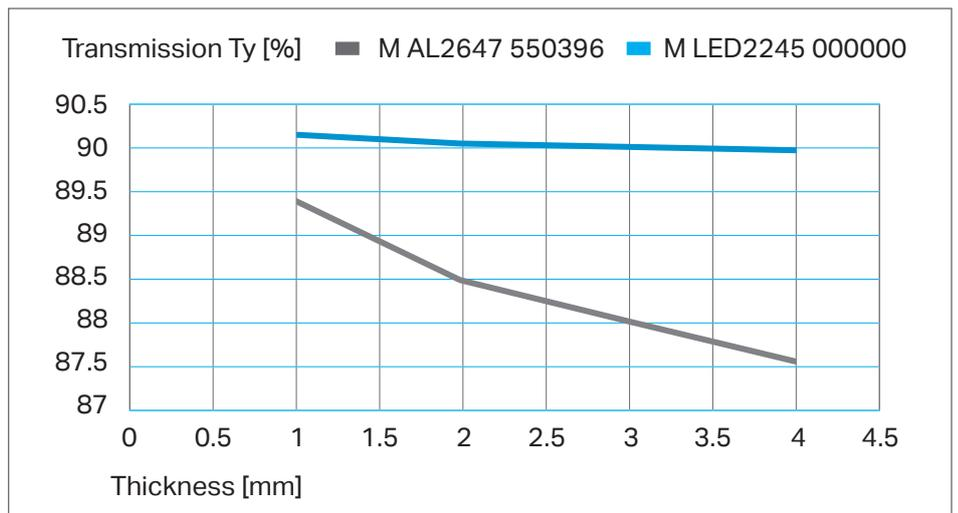

Fig. 3: Transmission Ty as a function of wall thickness, Makrolon® LED2245 000000 and Makrolon® AL2647 550396

B | Refractive index

The refractive index of Makrolon® is wavelength-dependent, as shown in Fig. 4 for Makrolon® LED2245 000000. The corresponding Abbé number is 30.

The Abbé number is defined as $[n(589\text{ nm})-1]/[n(486\text{ nm}) - n(656\text{ nm})]$.

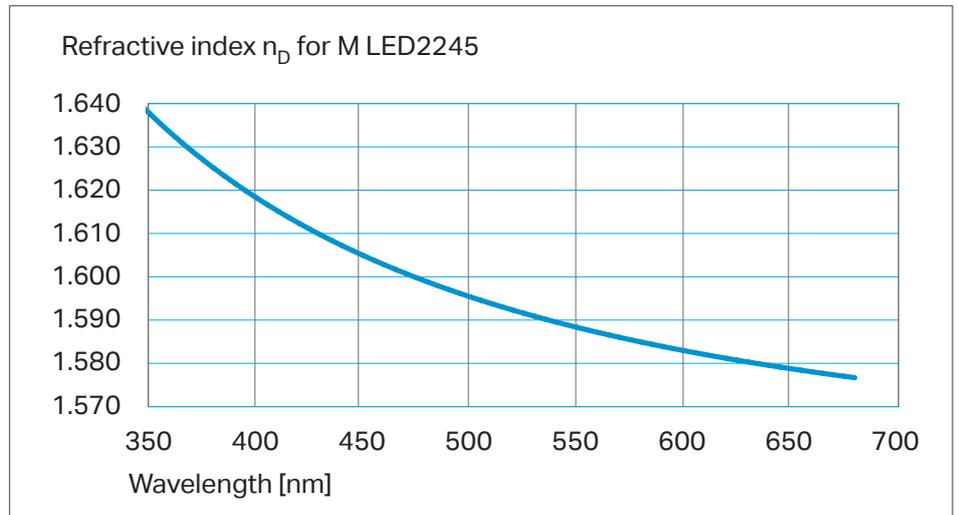

Fig. 4: Refractive index as a function of wavelength for the representative Makrolon® LED2245 000000

The other transparent Makrolon® grades have a very similar refractive index compared to Makrolon® LED2245 000000. Details are available on request.

The dependence of Makrolon's® refractive index n_D on temperature can be clearly illustrated by Makrolon® LED2245: The n_D value drops linearly as the temperature increases from -40 to 120°C.

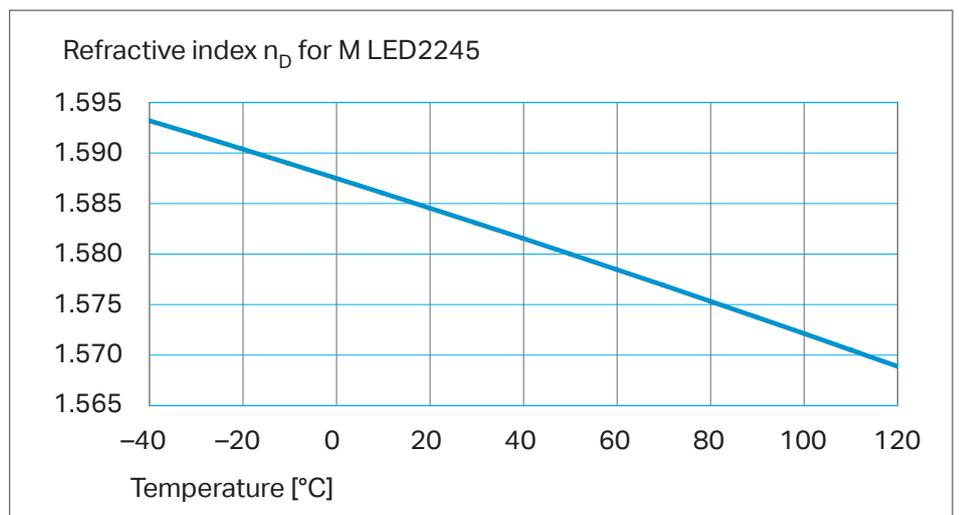

Fig. 5: Refractive index of Makrolon® LED2245 as a function of temperature

C | Weathering properties

The most visually perceptible change in Makrolon® when exposed to UV light, either in the form of outdoor weathering or artificial UV-emitting light sources, is yellowing. Other properties that deteriorate with weathering/UV exposure are:

Failure modes:

- Decreased transmission due to increased yellowing and haziness of the Makrolon®.
- Bleaching of tinted Makrolon®, both transparent and colored grades.
- Deterioration in surface properties, such as cracking and haze formation caused by extensive UV exposure.
- Deterioration in mechanical properties, e.g. impact strength and stiffness, due to the decomposition of Makrolon® initiated by UV light.

Therefore, UV stabilization is essential when parts made of Makrolon® are expected to withstand intensive UV exposure and harsh weather conditions. Based on state-of-the-art technologies, extensive product know-how and decades of experience, Covestro has developed various UV-protection solutions for Makrolon®, of which the most widely applied are (Fig. 6):

Approaches:

- UV absorber embedded in Makrolon® resin.
- Hardcoat concentrated with UV absorber.
- Coextruded Makrolon® layer concentrated with UV absorber.
- Combination of two or more of the above strategies.

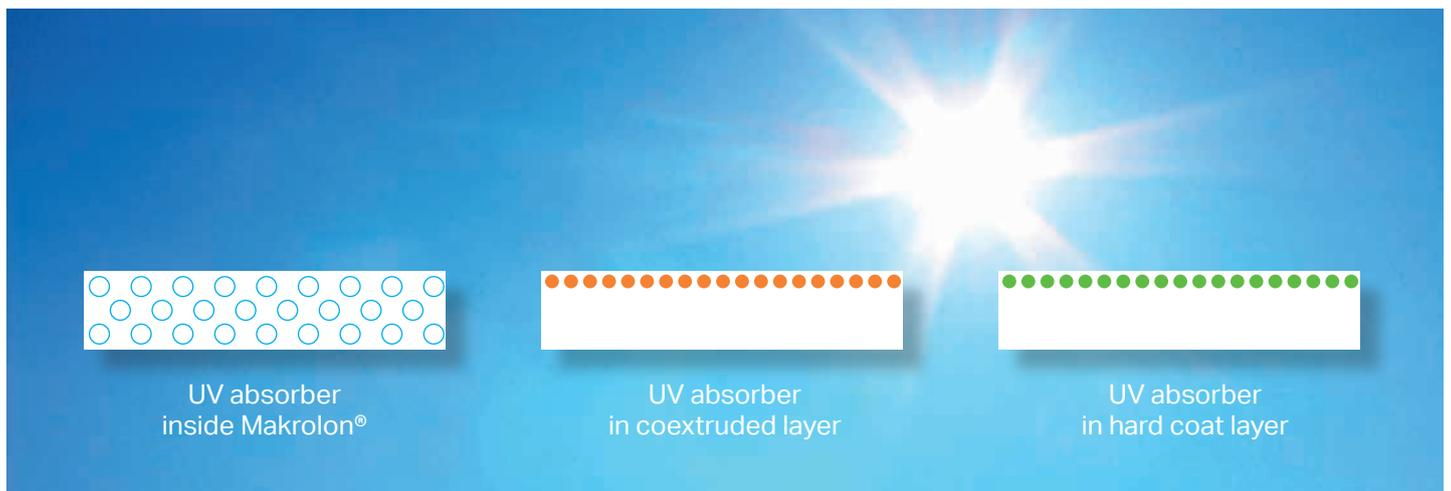

Fig. 6: Strategies for protecting Makrolon® against UV exposure and outdoor weathering

As illustrated in Fig. 7, the efficiency of the two strategies, i.e. UV absorber inside Makrolon® base material and UV absorber in coextruded layer, is evaluated quantitatively

by measuring the yellowness index YI (ASTM E313) over the testing period.

The coextruded Makrolon® layer and then the hardcoat concentrated with UV-absorber provide very efficient UV-protection for extruded and injection-molded Makrolon® products exposed to intense outdoor weathering. Depending on the applications, a lifetime of up to 20 years is achievable for coextruded Makrolon® sheets, as well as 3–12 years (3–6 years Florida or 6–12 years Germany) for hard-coated, injection-molded Makrolon® parts (4 mm thickness).

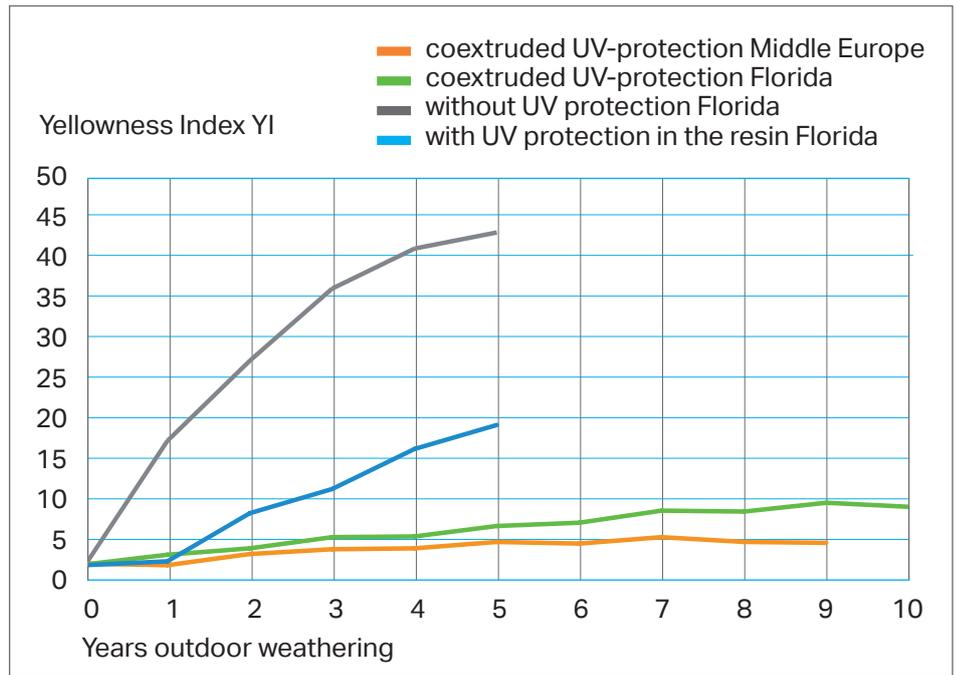

Fig. 7: Quantitative comparison of different UV stabilization solutions

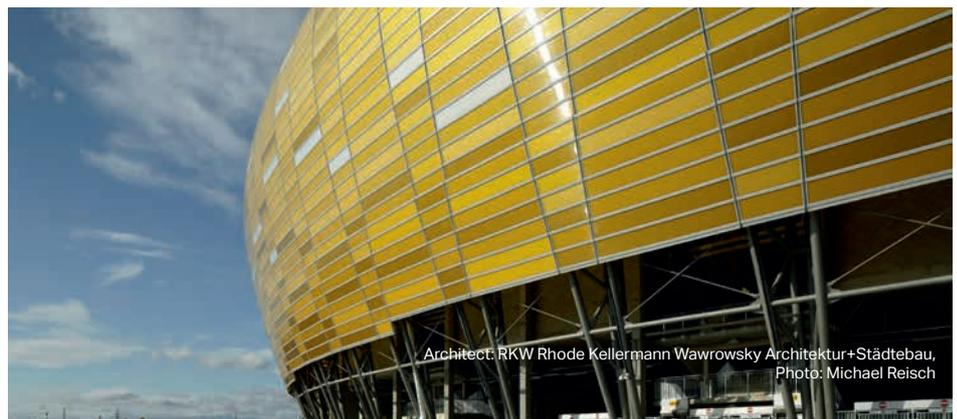

Fig. 8: Examples of UV-protected, coextruded Makrolon® sheets



Fig. 9: Examples of UV-protected, injection-molded Makrolon® parts with hardcoats

D | Temperature resistance

Components made of Makrolon® typically display high temperature resistance. A distinction is made between short-term temperature resistance and long-term temperature resistance. Different methods exist for measuring short-term temperature resistance, such as the glass transition temperature, Vicat softening point and heat distortion temperature (HDT). The short-term temperature resistance is comparably high within the group of clear, transparent Makrolon® grades.

Extended exposure to extreme temperatures leads to yellowing over time, depending on the temperature. The kinetics of yellowing also depend on the individual Makrolon® grade. Makrolon® LED2245 000000 and Makrolon® LED2045 000000 display the lowest tendency towards yellowing. This behavior is illustrated for Makrolon® LED2245 000000 in Fig. 10.

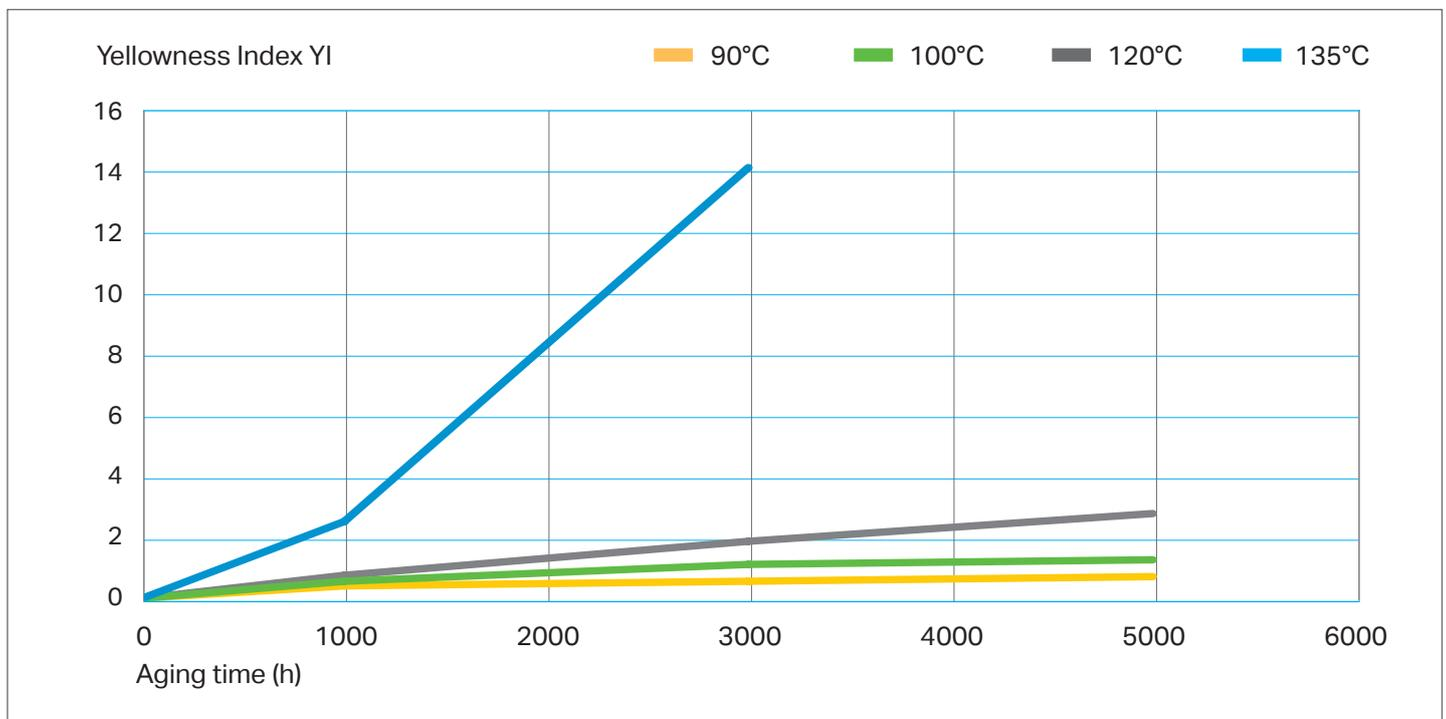

Fig. 10: Thermal aging of Makrolon® LED2245 000000 (4 mm) at different temperatures

Fig. 10 shows that Makrolon® LED2245 000000 displays a very low tendency towards yellowing at temperatures up to 120°C. In contrast, discoloration occurs much more rapidly at 135°C.

Apart from yellowing, other changes in properties can also occur after extended exposure to high temperatures.

However, yellowing is the first indication; other phenomena, such as loss of transmittance or the gradual appearance of a cloudy haze, occur only after even longer exposure to heat. Nonetheless, the mechanical properties, such as good impact strength, remain on a high level even after an extended period of time.

E | Aging under artificial light sources

LEDs, halogen lamps and gas discharge lamps are artificial light sources with high radiant intensity. The question often arises as to how resistant Makrolon® is to these light sources. Clear, transparent Makrolon® basically is very resistant to these light sources, even at a high radiant flux, provided they contain no UV light (<400 nm). For example, suitable, UV-absorbing glass bulbs can filter out residual UV radiation. In the case of minimal UV we may evaluate on request how critical the situation is.

LEDs are a special case. At moderate radiant intensities, all clear and transparent Makrolon® grades are very resistant to LED light. However, high radiant intensities or LEDs with peak wavelengths less than 450 nm may still lead to material damage. To fulfill the stringent requests of demanding applications, e.g. automotive headlamps, Covestro has developed specialty polycarbonate Makrolon® LED grades, which are easy-flowing, highly transparent and have particularly high resistance to LED light.



Fig. 11: LED headlamp in the Audi A8 using Makrolon® LED2245 for low beams and daytime running lights

3 Signal colors

Makrolon® and Apec® are available in almost any transparent color.

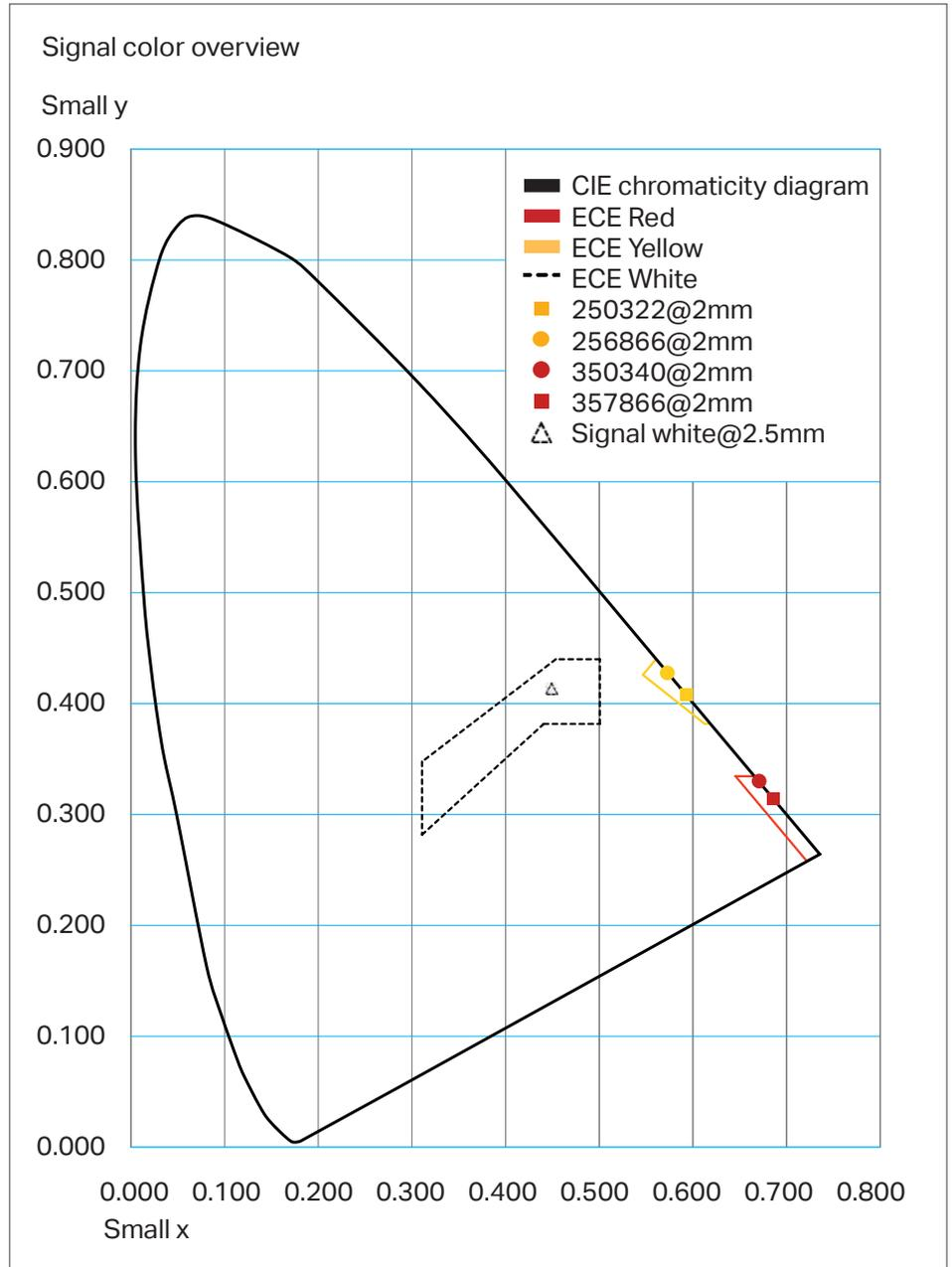

Fig. 12: Positions of the main signal color ranges in the CIE chromaticity diagram (typical color coordinates; may vary within tolerance)

Makrolon® and Apec® transparent signal colors have been used for many years in various applications, such as automotive lighting, signal transmitters and signal lights. Furthermore, thanks to their excellent mechanical properties and very high heat resistance, Makrolon® and Apec® are not only qualified for standard applications, such as turns signals, rear lights, traffic lights and warning lights on

emergency vehicles, but also ideal for harsher environments, e.g. in aircraft, rail and shipping applications. Fig.12 shows the current range of signal colors in accordance with the standard specifications in the CIE chromaticity diagram. Some of the typical signal colors – white, yellow and red – are shown in the diagram to represent the large number of signal colors available.

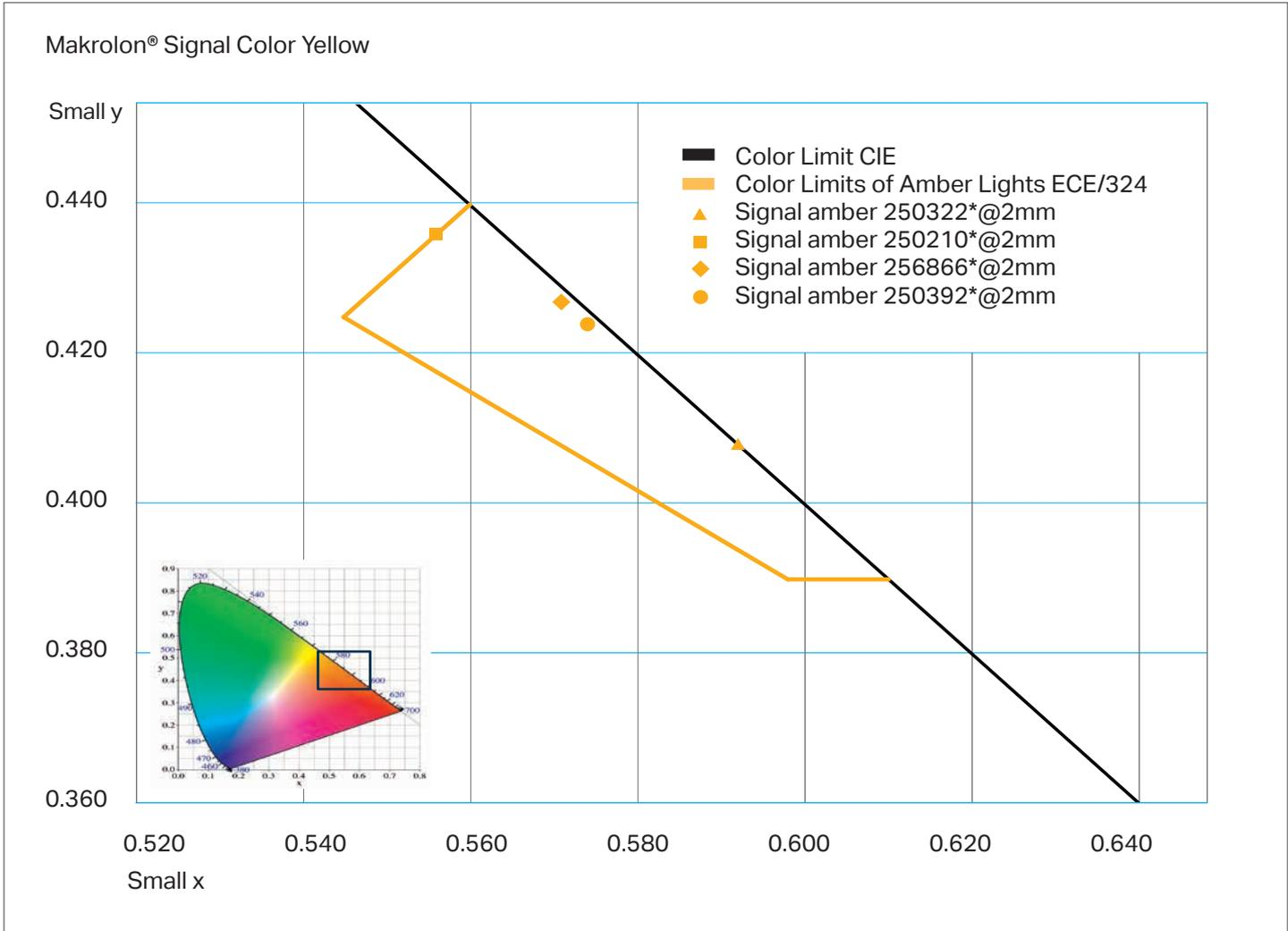

Fig. 13: Position of the yellow signal range in the CIE chromaticity diagram and important signal colors
 * Typical color coordinates; may vary within tolerance

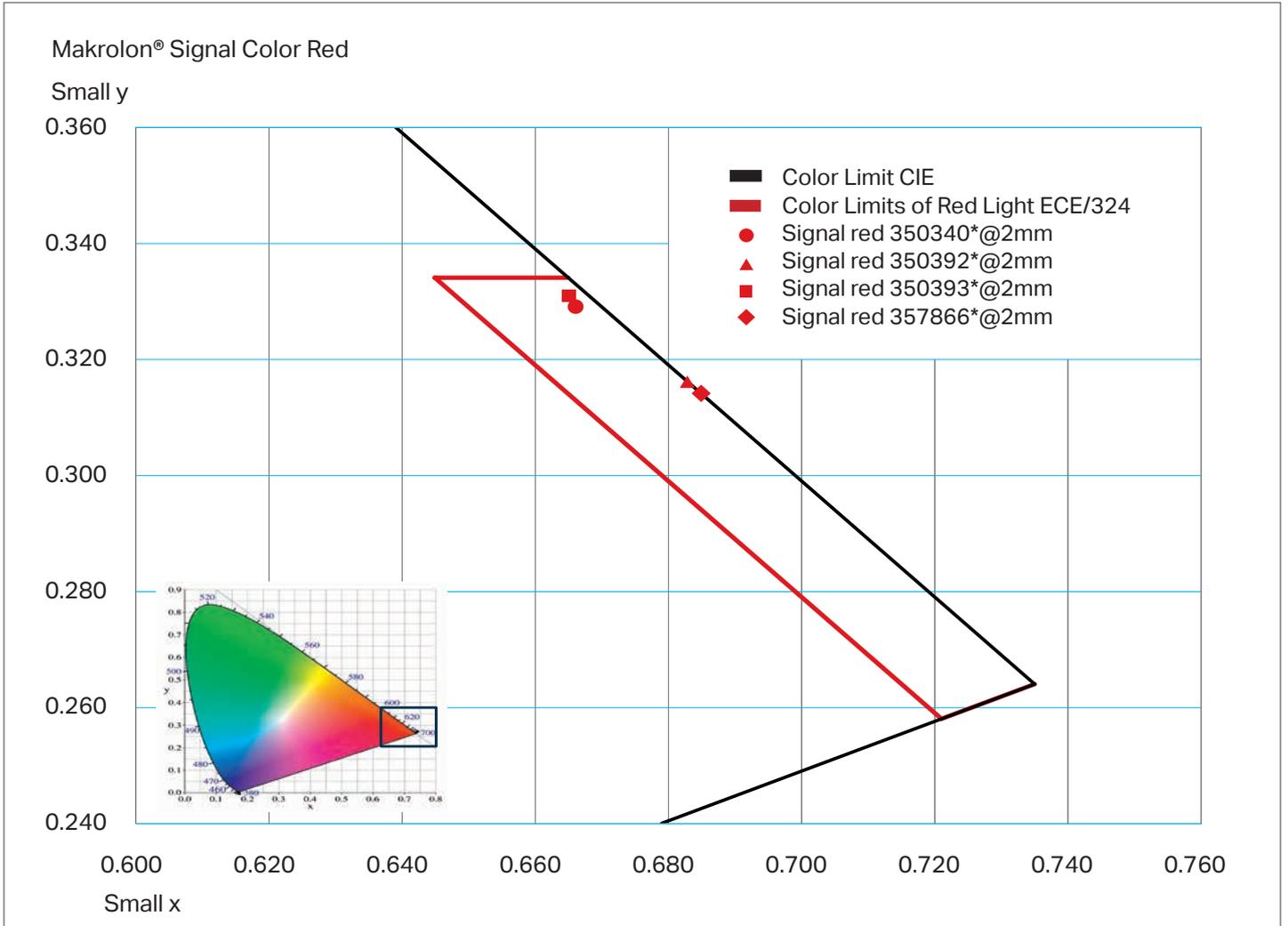

Fig. 14: Position of the red signal range in the CIE chromaticity diagram and important signal colors
 * Typical color coordinates; may vary within tolerance

The colorimetric guide data for the signal colors were calculated in accordance with light type A, 2° observer. Fig. 13 and 14 show the exact positions of several of the most common yellow and red signal colors in automotive lighting in the CIE chromaticity diagram. It should be noted

that wall thickness influences not only the transmittance, but also the color parameters, meaning that colors for wall thicknesses other than 2 mm (Fig. 13 and 14) will appear at different positions in the CIE chromaticity diagram.

4 High-reflectance white

Characterized by their high efficiency in diffuse reflecting visible light, high-reflectance white Makrolon® grades are noted for their increasing application as ideal raw materials for LED rear lamp reflectors. Other applications include construction, lighting, automotive and household appliances. A diffuse reflection ratio as high as ca. 95% can be

achieved. Fig. 15 shows the reflectance spectra in the visible range of several representative colors.

Makrolon® RW grades show very low transmission even at thin wall thickness and are also suitable to block light very efficiently. More details on request.

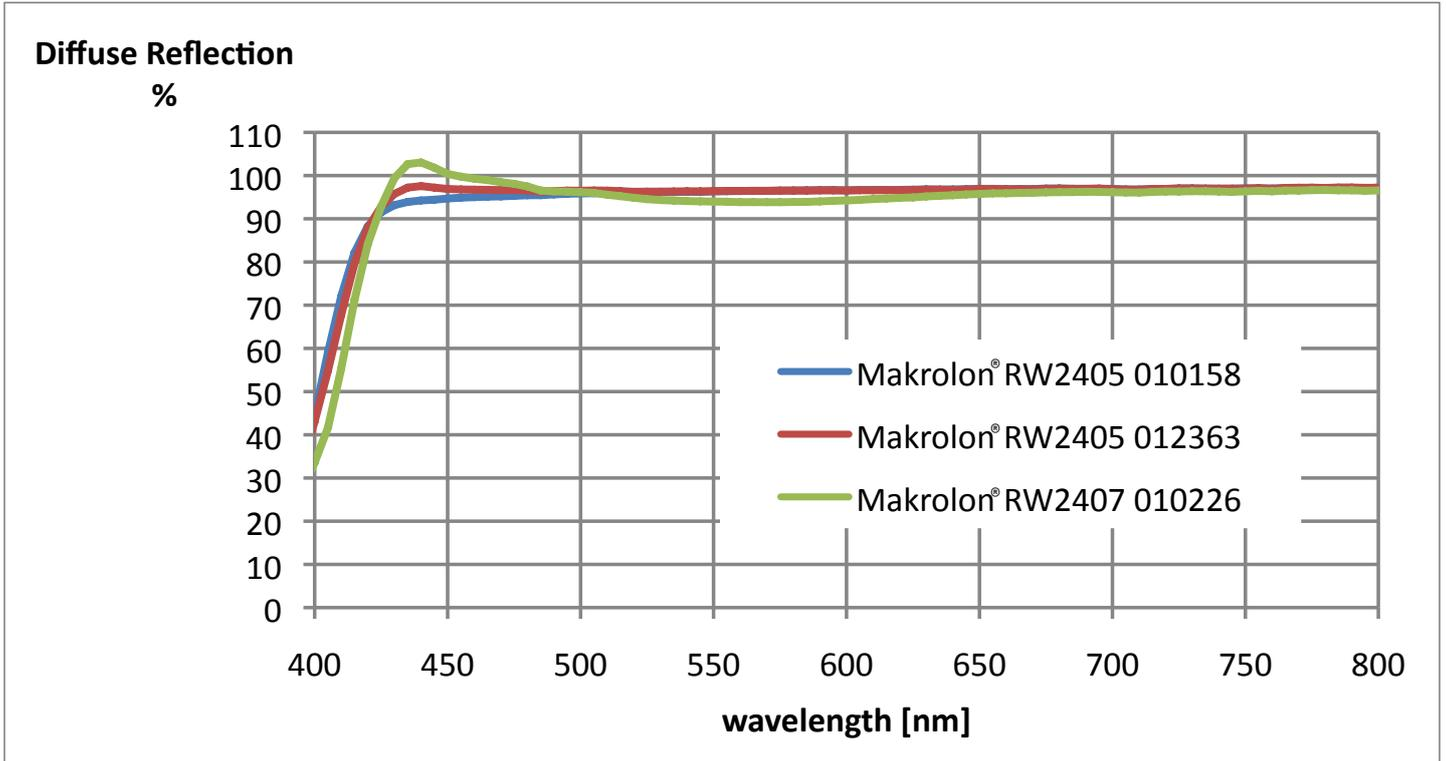

Fig. 15: Diffuse reflectance spectra of several high-reflectance white Makrolon® colors

5 Special colors

A | NIR-transparent black

Black-tinted Makrolon® normally has the color code 901510. This material exhibits very high surface quality and high gloss. The color is very resistant to the effects of light and largely opaque to visible and infrared light. Special color formulations were developed that appear to be black, but display high transmittance in the near-infrared range (NIR). In addition to very high surface quality and high gloss, these color formulations also show an enhanced depth effect. These NIR-transparent colors can be used for aesthetic reasons, and for applications in which high transmittance in the NIR is required, e.g. signal transmission in the NIR, such as light barriers and remote controls, and in joining processes, such as laser welding in the NIR.

Color formulations are available with different spectra (Fig. 16).

B | NIR-absorbing grades

In addition to NIR-transparent black, Covestro also developed specialty color formulations featuring high absorption in the NIR but high transmittance in the visible range. These characteristics are particularly required, for instance, in

C | Laser-marking colors

Makrolon® can be inscribed using commercial laser systems. Covestro offers a variety of color formulations that

automotive sunroofs made of Makrolon® AG to reduce the penetration of heat into the interior, or in various types of protective eyewear. Details are available on request.

support enhanced contrast, both in the color and in better resolution. Details are available on request.

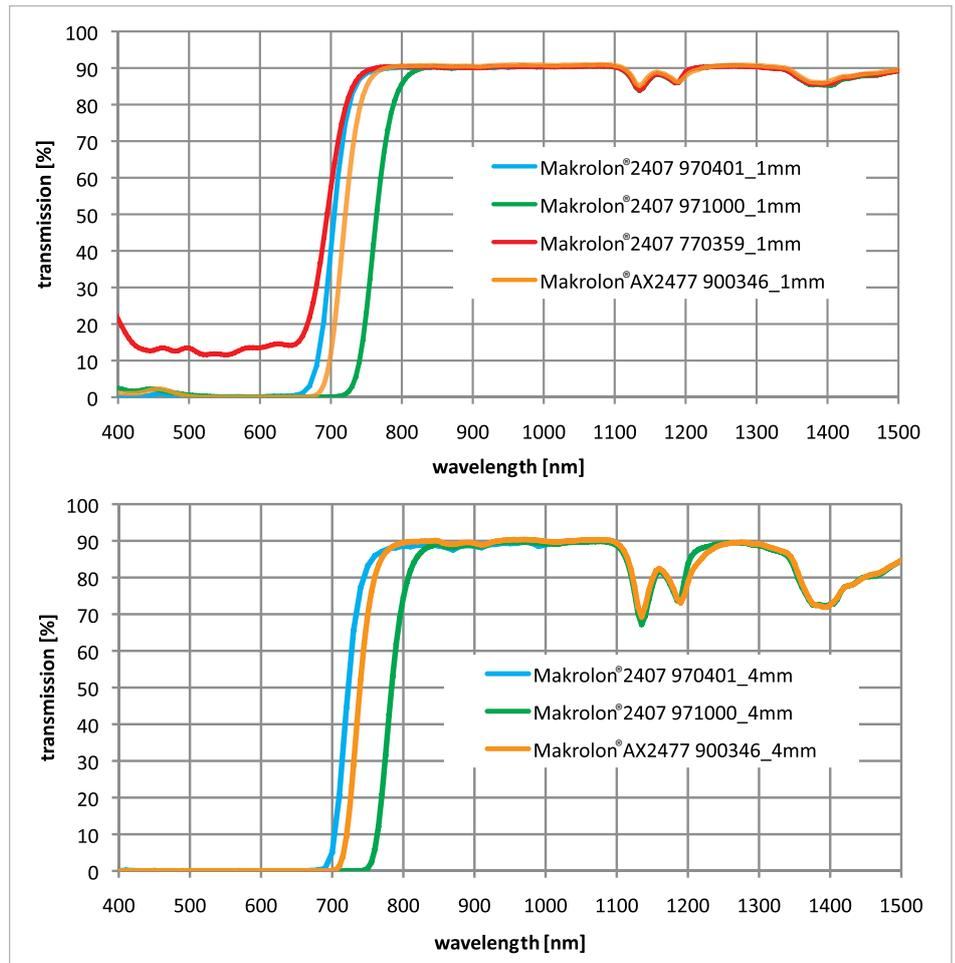

Fig. 16: Transmission spectra of NIR-transparent color shades for thicknesses of 1 mm and 4 mm

6 Translucent grades

Covestro offers various translucent grades with different transmittance, scattering properties and color impression.

Makrolon® grade (all UV stabilized)	Intended Application	Color Code	MVR* (cm ³ /10 min)	Transmittance (%) @ 2 mm	Half Power Angle (°) @ 2 mm	Visual Color Impression
2407	Injection Molding	021172	19	76	26	warm white
2407	Injection Molding	021441	19	70	36	warm white
2407	Injection Molding	021468	19	64	43	warm white
2407	Injection Molding	021531	19	85	5	cool white
2407	Injection Molding	021533	19	68	36	cool white
2407	Injection Molding	021182	19	57	48	cool white
ET3117	Tubes	16F122MA	6	53	57	cool white
ET3117	Tubes	021696	6	64	40	cool white
ET3137	Profiles	021703	6	56	48	cool white
ET3137	Profiles	021458	6	49	53	cool white
ET3227	Complex profiles	021298	3	56	41	cool white

* MVR = Melt Volume Rate

Tab. 3: Selection of translucent Makrolon® grades

Two colors, 021172 and 021182, are selected as examples to describe the optical properties.

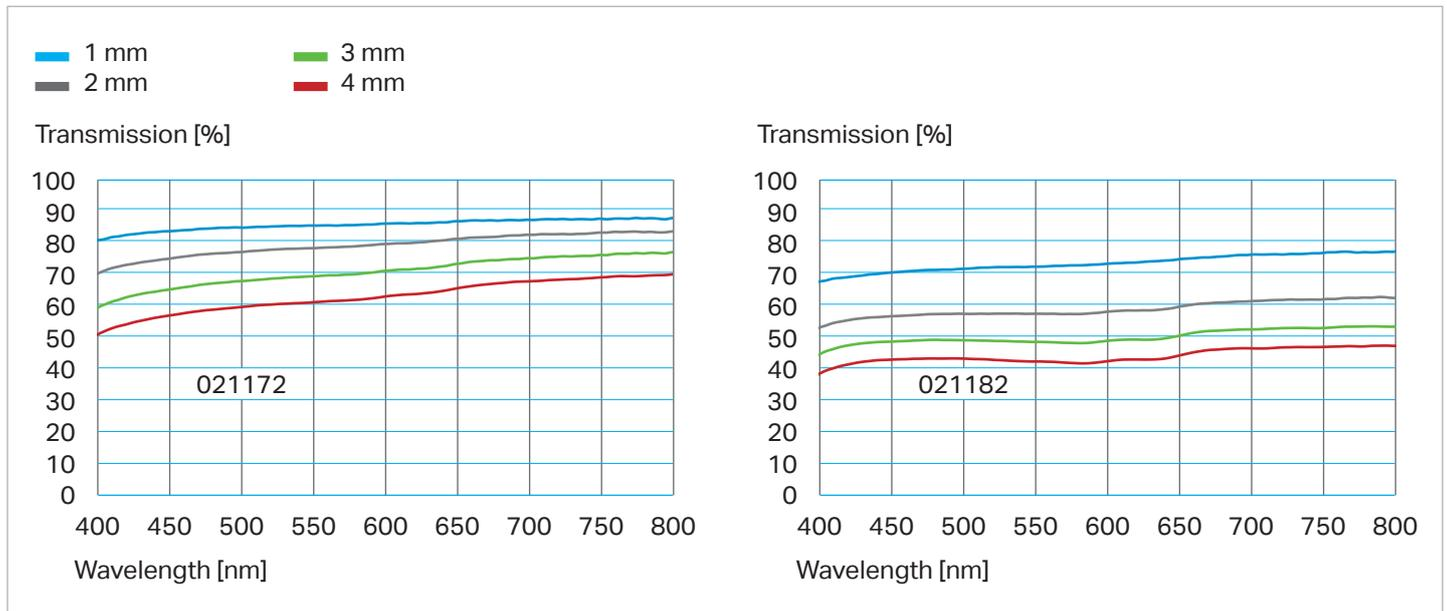

Fig. 17: Transmission spectra of the selected grades in different thicknesses

To characterize the scattering properties, the following setup is usually chosen. The sample is covered by a mask with a small hole and is illuminated from the back. The light intensity shining through the hole is determined under different angles with a goniometer (see Fig. 18). The angle at which the light intensity is reduced to half of the maximum is called the "half-power angle" (HPA). The bigger the half-power angle is, the stronger the scattering efficiency will be.

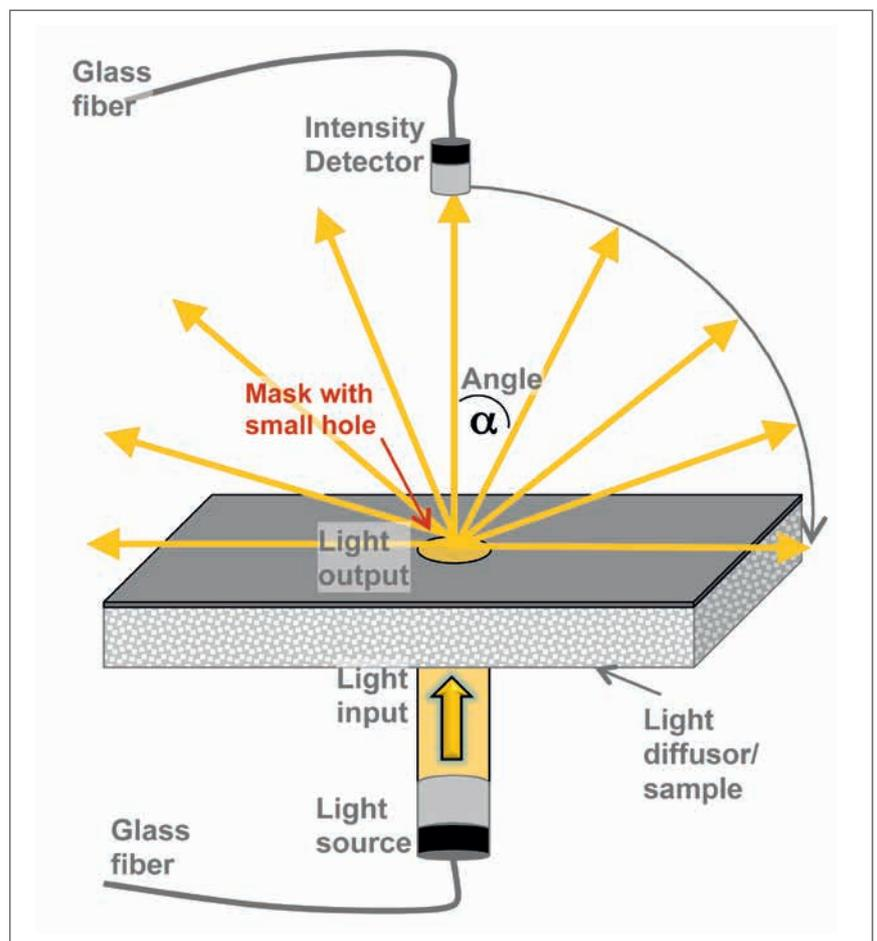

Fig. 18: Goniometer measurement setup

Other methods to characterize scattering properties include e.g. diffusion factor DF or hiding power HP. The half-power angle can also be determined by "luminosity", which leads to a different HPA value than in the case of light intensity. All HPA values mentioned in this chapter are measured based on light intensity.

Translucent properties can be achieved by adding special scattering agents. Increasing the dosage of scattering agents

leads to increase of the half-power angle, while the luminous transmission will decrease. Same with sample thickness: Thicker samples result in a bigger half-power angle and lower luminous transmission. Therefore, it is the challenge for each application to find the right balance.

This behavior is shown for thicknesses of 1, 2, 3 and 4 mm in Fig. 19 and Tab. 4.

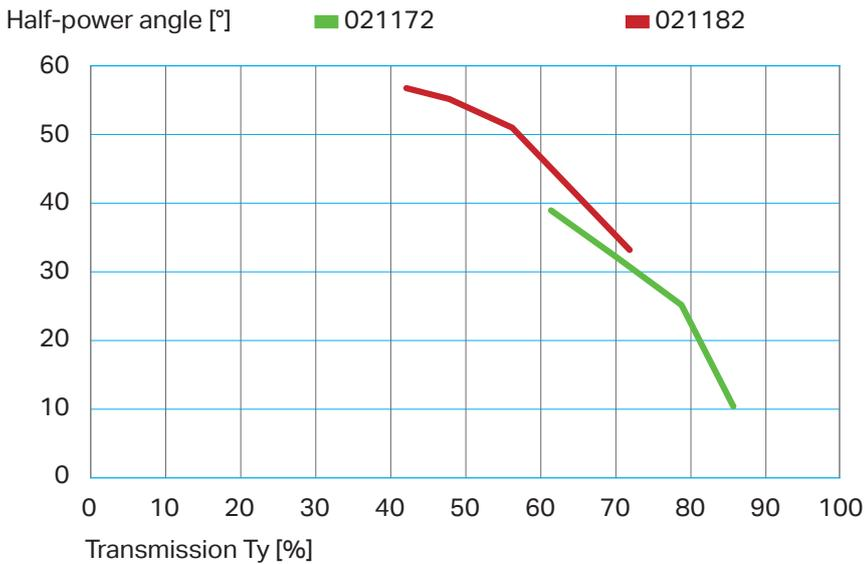

Fig. 19: Half-power angle and transmission of selected translucent colors

		Hunter Ultra ScanPR	Byk Gardner haze guard	Mini Diff Light TEC		
Color code	Thickness (mm)	Ty (D65 10°) (%)	Haze (%)	Half-power angle (HPA) (°)	Diffusion factor (DF) (%)	Hiding power (HP) (%)
021172	1	85	98.6	10	17	86
	2	78	100	25	34	100
	3	69	100	33	43	100
	4	61	100	39	47	100
021182	1	72	100	33	45	94
	2	56	100	51	57	100
	3	48	100	55	60	100
	4	42	100	56	61	100

Tab. 4: Scattering properties of translucent grades (typical values, no specification)

In some publications, the scattering performance is visualized by polar coordinates. This is shown for our materials in Fig. 20. In Fig. 20, the theoretical limit of Lambertian scattering performance was added. This is to underline that the scattering performance, especially of color 021182, is close to the theoretical limit.

In order to help the customers to accelerate the material selection process, Covestro also offers standard color chips of various thicknesses. Details are available on request.

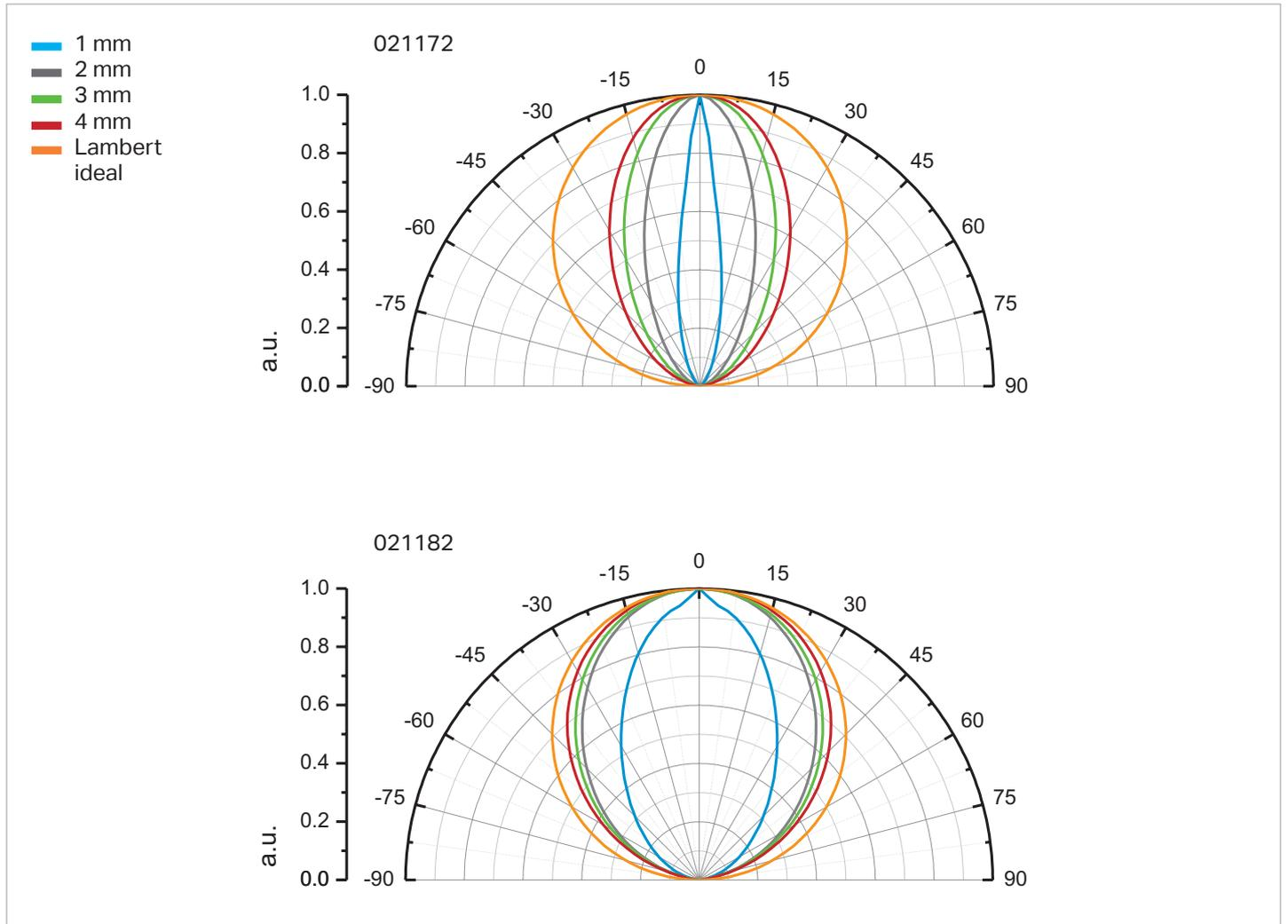

Fig. 20: Scattering performance of translucent sample set expressed by polar coordinates

7 Apec® – High-temperature-resistant polycarbonate

Apec® is a further development of Makrolon® that offers even higher heat resistance. The copolycarbonate is made of bisphenol A (building block of Makrolon®) and another monomer, bisphenol TMC. Varying the ratios of the two components

results in products having heat resistance values as high as 202°C (Vicat softening temperature). The typical properties of the clear, transparent Apec® grades are summarized in Tab. 5.

Properties*	High-flow Apec® grades				High-viscosity grades	
	Apec® 1695/1697	Apec® 1795/1797	Apec® 1895/1897	Apec® 2097	Apec® 1703	Apec® 1803
Crystal-clear color	551022	551022	551022	551022	551022	551022
Vicat-Temperature* (50N 120 K/h ISO306)	158°C/157°C	173°C/172°C	183°C/182°C	202°C	171°C	184°C
Transmission Ty* (1 mm DIN5036-1)	89%	89%	89%	89%	89%	89%
Refractive index nD (ISO489A)	1.578	1.576	1.573	1.566	1.578	1.573
Abbé number	30	30	30	31	30	30
RTI relative temperature index (static yield stress) (UL746B)	140°C	140°C	150°C	150°C	150°C	150°C
UV protection	no/yes	no/yes	no/yes	yes	yes	yes
Additional approvals					AMECA	AMECA

* Typical value, no specification

Tab. 5: Optical properties of Apec® grades



Apec's® transmittance is comparable to that of Makrolon®:

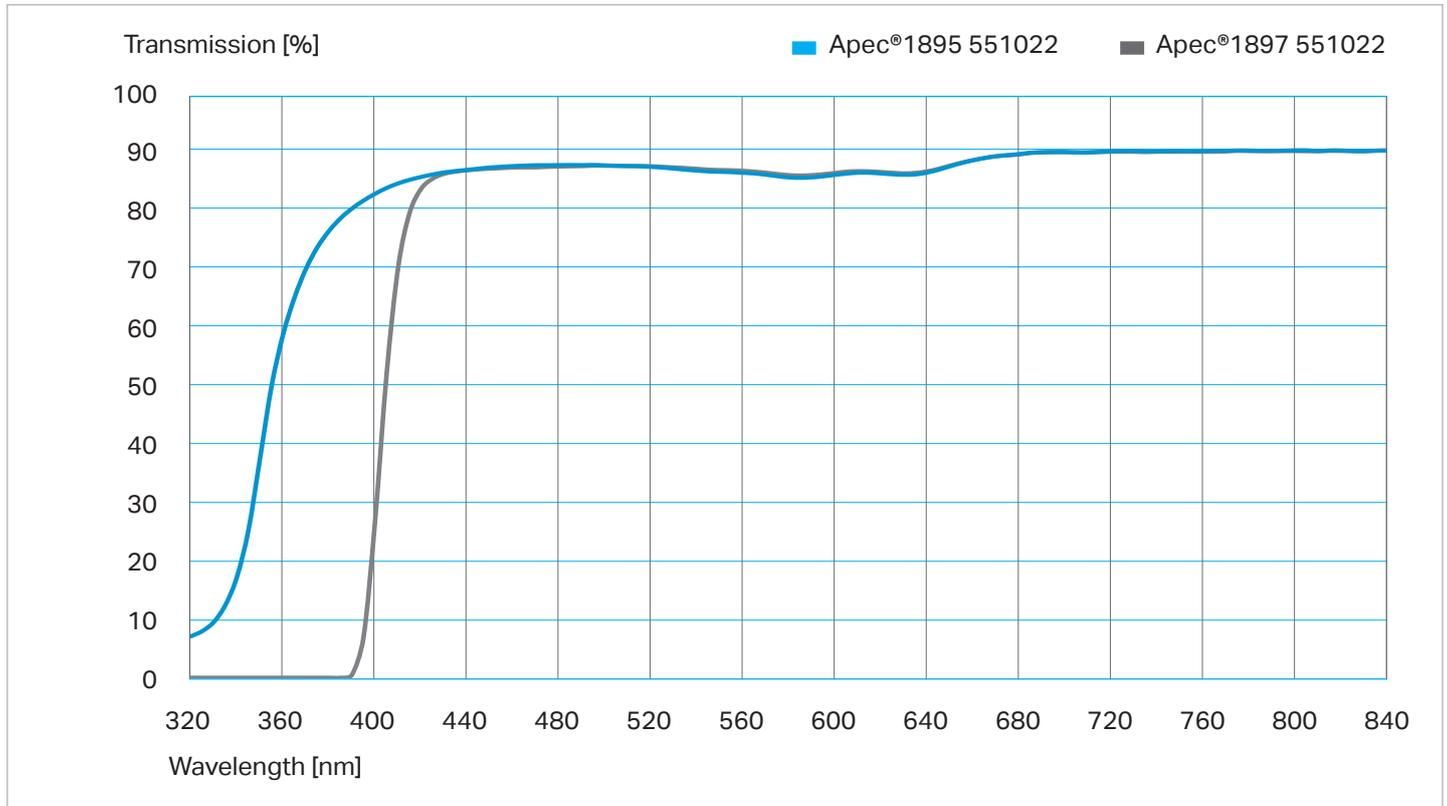

Fig. 21: Transmission spectra of Apec® 1895 551022 and Apec® 1897 551022 (4 mm)

The variable composition of the Apec® grades is reflected by their refractive index (Fig. 22). As the bisphenol TMC content rises (rising heat resistance), the refractive index drops.

The dispersion of the refractive index is similar to that of Makrolon®, but shifted as a function of on the bisphenol TMC content.

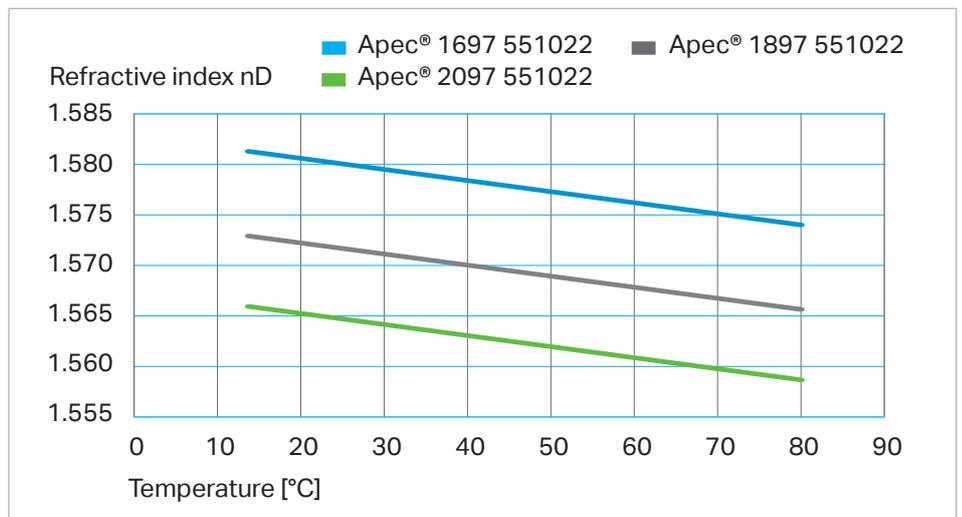

Fig. 22: Refractive index nD as a function of temperature

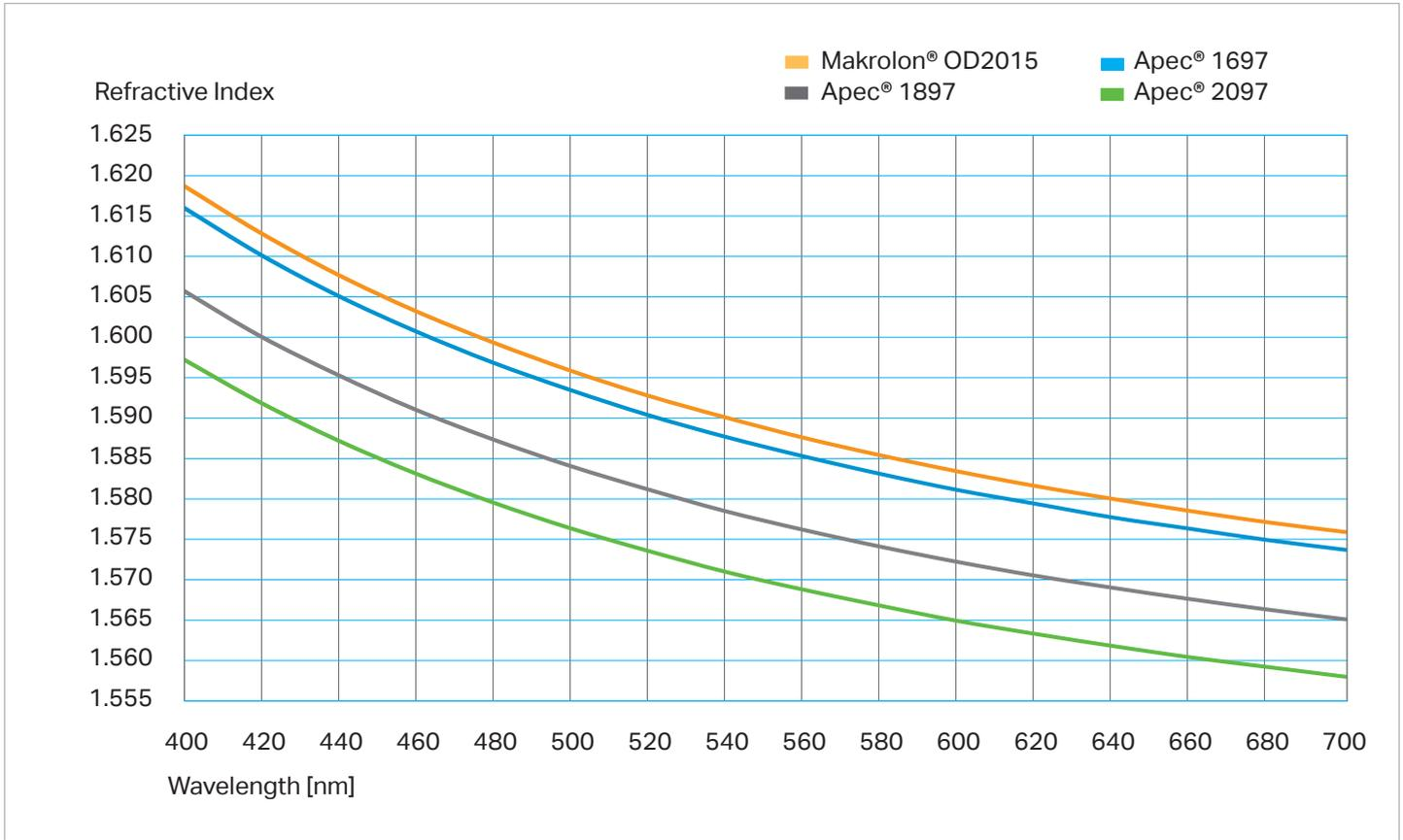

Fig. 23: Refractive index as a function of wavelength

Apec® grades are frequently used in Makrolon® applications where elevated temperatures occur, particularly in automotive lighting.

Detailed information on the Apec® grades is available in the brochure: "Overview of Apec® product grades – Reference values."

8 Appendix – Typical properties of Makrolon® and Apec®

Makrolon®				
Properties	Test conditions	Units	Standards	
Rheological properties				
C	Melt volume-flow rate (MVR)	250°C; 2.16 kg	cm ³ /10 min	ISO 1133
C	Melt volume-flow rate (MVR)	300°C; 1.2 kg	cm ³ /10 min	ISO 1133
	Melt mass-flow rate (MFR)	300°C; 1.2 kg	g/10 min	ISO 1133
	Molding shrinkage, parallel	60 x 60 x 2; 500 bar	%	ISO 294-4
	Molding shrinkage, normal	60 x 60 x 2; 500 bar	%	ISO 294-4
Mechanical properties (23°C/50% r. F.)				
C	Tensile modulus	1 mm/min	MPa	ISO 527-1,-2
C	Yield stress	50 mm/min	MPa	ISO 527-1,-2
C	Yield strain	50 mm/min	%	ISO 527-1,-2
C	Nominal strain at break	50 mm/min	%	ISO 527-1,-2
	Flexural modulus	2 mm/min	MPa	ISO 178
	3.5% flexural stress	2 mm/min	MPa	ISO 178
	Flexural strength	2 mm/min	MPa	ISO 178
C	Charpy impact strength	23°C	kJ/m ²	ISO 179-1eU
	Charpy notched impact strength	23°C; 3 mm	kJ/m ²	ISO 7391/i.A. ISO 179-1eA
	Charpy notched impact strength	-30°C; 3 mm	kJ/m ²	ISO 7391/i.A. ISO 179-1eA
	Izod notched impact strength	23°C; 3 mm	kJ/m ²	ISO 7391/i.A. ISO 180-A
C	Puncture maximum force	23°C	N	ISO 6603-2
C	Puncture energy	23°C	J	ISO 6603-2
Thermal properties				
C	Temperature of deflection under load	1.80 MPa	°C	ISO 75-1,-2
C	Temperature of deflection under load	0.45 MPa	°C	ISO 75-1,-2
C	Vicat softening temperature	50 N; 50°C/h	°C	ISO 306
C	Coefficient of linear thermal expansion, parallel	23 bis 55°C	10 ⁻⁴ /K	ISO 11359-1,-2
C	Coefficient of linear thermal expansion, normal	23 bis 55°C	10 ⁻⁴ /K	ISO 11359-1,-2
C	Burning behavior UL 94 (1.5 mm)	1.5 mm	Class	UL 94
C	Burning behavior UL 94-5V	3.0 mm	Class	UL 94
C	Oxygen index	Method A	%	ISO 4589-2
	Glow wire test (GWFI)	1.5 mm	°C	IEC 60695-2-12
	Glow wire test (GWFI)	3.0 mm	°C	IEC 60695-2-12
	Glow wire test (GWIT)	1.5 mm	°C	IEC 60695-2-13
	Glow wire test (GWIT)	3.0 mm	°C	IEC 60695-2-13
Electrical properties (23°C/50% r. F.)				
C	Relative permittivity	100 Hz	–	IEC 60250
C	Relative permittivity	1 MHz	–	IEC 60250
C	Dissipation factor	100 Hz	10 ⁻⁴	IEC 60250
C	Dissipation factor	1 MHz	10 ⁻⁴	IEC 60250
C	Volume resistivity	–	Ohm·m	IEC 60093
C	Volume resistivity	–	Ohm	IEC 60093
C	Electrical strength	1 mm	kV/mm	IEC 60243-1
C	Comparative tracking index CTII	Solution A	Rating	IEC 60112
Other properties (23°C)				
C	Water absorption (Saturation value)	Water at 23°C	%	ISO 62
C	Water absorption (Equilibrium value)	23°C; 50% r.F.	%	ISO 62
C	Density	–	kg/m ³	ISO 1183-1
Material specific properties				
	Refractive index	Methode A	–	ISO 489
	Luminous transmittance (clear transparent materials)	1 mm	%	ISO 13468-2
C	Luminous transmittance (clear transparent materials)	2 mm	%	ISO 13468-2
	Luminous transmittance (clear transparent materials)	3 mm	%	ISO 13468-2
Processing conditions for test specimens				
C	Injection molding melt temperature	–	°C	ISO 294
C	Injection molding mold temperature	–	°C	ISO 294
C	Injection molding flow front velocity	–	mm/s	ISO 294

Standard grades								Optical grades						
Low-viscosity								Optical data storage	Eyewear	Lightguide		Automotive-lighting		
2205	2207	2405	2407	2605	2607	2805	2807	OD2015	LQ2647	LED2045	LED2245	AL2447	AL2647	
34	34	19	19	12	12	9.0	9.0	17	12	17	34	19	12	
37	37	20	20	13	13	10	10		13		37	20	13	
0.65	0.65	0.65	0.65	0.65	0.65	0.65	0.65	0.6	0.65	0.6	0.65	0.65	0.65	
0.65	0.65	0.65	0.65	0.7	0.7	0.7	0.7	0.6	0.7	0.6	0.65	0.65	0.7	
2400	2400	2400	2400	2400	2400	2400	2400	2350	2400	2350	2350	2400	2400	
65	65	65	66	66	66	66	66	63	67	63	63	66	67	
6.0	6.0	6.0	6.0	6.1	6.1	6.2	6.1	5.9	6.1	6.0	6.0	6.0	6.1	
> 50	> 50	> 50	> 50	> 50	> 50	> 50	> 50	> 50	> 50	> 50	> 50	> 50	> 50	
2350	2350	2350	2350	2400	2400	2400	2400	2350	2400	2350	2350	2350	2400	
73	74	73	74	73	74	73	74	72	74	72	73	74	74	
97	98	97	98	97	98	97	98	97	98	97	97	98	98	
N	N	N	N	N	N	N	N	N	N	N	N	N	N	
55P(C)	55P(C)	65P	65P(C)	70P	70P	75P	75P	50P(C)	70P	50P(C)	60P(C)	65P(C)	70P	
12C	12C	14C	14C	16C	14C	16C	14C	12C	14C	12C	12C	14C	14C	
65P(C)	65P(C)	75P(C)	75P(C)	70P	70P	75P	75P	50P(C)	70P(C)	50P	60P(C)	75P(C)	80P(C)	
4900	4900	5100	5100	5400	5400	5400	5400	4700	5400	4700	4900	5100	5400	
55	55	55	55	60	60	60	60	50	60	50	55	55	60	
124	123	124	124	125	123	125	124	124	123	124	125	125	123	
137	136	137	136	136	135	137	136	138	135	137	138	138	136	
145	143	145	143	144	143	144	143	145	143	145	145	144	143	
0.65	0.65	0.65	0.65	0.65	0.65	0.65	0.65	0.65	0.65	0.65	0.65	0.65	0.65	
0.65	0.65	0.65	0.65	0.65	0.65	0.65	0.65	0.65	0.65	0.65	0.65	0.65	0.65	
V2	V2	V2	V2	V2	V2	V2	V2		V2		V2	V2	V2	
HB	HB	HB	HB	HB	HB	HB	HB		HB		HB	HB	HB	
28	28	27	27	28	28	28	28	28	28	27	28	28	28	
875	875	875	875	850	850	875	875				875			
930	930	930	930	930	930	930	930	960			930			
875	875	875	875	875	875	875	875				875			
875	875	875	875	875	875	900	875				900			
3.1	3.1	3.1	3.1	3.1	3.1	3.1	3.1	3.1	3.1	3.1	3.1	3.1	3.1	
3.0	3.0	3.0	3.0	3.0	3.0	3.0	3.0	3.0	3.0	3.0	3.0	3.0	3.0	
5	5	5	5	5	5	5	55	5	5	5	5	5		
90	90	90	90	90	90	90	90	95	90	90	95	90	90	
1E14	1E14	1E14	1E14	1E14	1E14	1E14	1E14	1E14	1E14	1E14	1E14	1E14	1E14	
1E16	1E16	1E16	1E16	1E16	1E16	1E16	1E16	1E16	1E16	1E16	1E16	1E16	1E16	
34	34	34	34	34	34	34	34	34	34	34	34	34	34	
250	250	250	250	250	250	250	250	225	250	225	250	250	250	
0.30	0.30	0.30	0.30	0.30	0.30	0.30	0.30	0.30	0.30	0.30	0.30	0.30	0.30	
0.12	0.12	0.12	0.12	0.12	0.12	0.12	0.12	0.12	0.12	0.12	0.12	0.12	0.12	
1190	1190	1200	1200	1200	1200	1200	1200	1190	1.200	1190	1190	1200	1200	
1.584	1.584	1.585	1.585	1.585	1.585	1.586	1.586	1.584	1.585	1.584	1.584	1.585	1.585	
89	89	89	89	89	89	89	89	> 89	89	90	90	89	89	
89	89	89	89	89	89	89	89		89	90	90	89	89	
88	88	88	88	88	88	88	88		88	> 89	> 89	88	88	
280	280	280	280	290	290	300	300	280	290	280	280	280	290	
80	80	80	80	80	80	80	80	80	80	80	80	80	80	
200	200	200	200	200	200	200	200	200	200	200	200	200	200	

Properties	Test conditions	Units	Standards	
Rheological properties				
C	Melt volume-flow rate (MVR)	330°C; 2.16 kg	cm ³ /10 min	ISO 1133
	Melt mass-flow rate (MFR)	330°C; 2.16 kg	g/10 min	ISO 1133
	Molding shrinkage, parallel	60 x 60 x 2 mm	%	ISO 294-4
	Molding shrinkage, transverse	60 x 60 x 2 mm	%	ISO 294-4
Mechanical properties (23°C/50% r. h.)				
C	Tensile modulus	1 mm/min	MPa	ISO 527-1,-2
C	Yield stress	50 mm/min	MPa	ISO 527-1,-2
C	Yield strain	50 mm/min	%	ISO 527-1,-2
C	Nominal strain at break	50 mm/min	%	ISO 527-1,-2
C	Charpy impact strength	23°C	kJ/m ²	ISO 179-1eU
C	Charpy impact strength	-30°C	kJ/m ²	ISO 179-1eU
C	Charpy notched impact strength	23°C	kJ/m ²	ISO 179-1eA
C	Charpy notched impact strength	-30°C	kJ/m ²	ISO 179-1eA
	Flexural modulus	2 mm/min	MPa	ISO 178
	Flexural strength	2 mm/min	MPa	ISO 178
	Ball indentation hardness	-	N/mm ²	ISO 2039-1
Thermal properties				
C	Deflection temperature under load, Af	1.80 MPa	°C	ISO 75-1,-2
C	Deflection temperature under load, Bf	0.45 MPa	°C	ISO 75-1,-2
	Vicat softening temperature	50 N; 120°C/h	°C	ISO 306
	Relative temperature index (tensile strength)	1.5 mm; 3.0 mm	°C	UL 746B
	Relative temperature index (tensile impact strength)	1.5 mm; 3.0 mm	°C	UL 746B
	Relative temperature index (electric strength)	1.5 mm; 3.0 mm	°C	UL 746B
C	Coefficient of linear thermal expansion, parallel	23 to 55°C	10 ⁻⁴ /K	ISO 11359-1,-2
C	Coefficient of linear thermal expansion, transverse	23 to 55°C	10 ⁻⁴ /K	ISO 11359-1,-2
C	Burning behavior UL 94 (1.5 mm)	1.5 mm	Class	UL 94
C	Burning behavior UL 94	3.0 mm	Class	UL 94
C	Oxygen index	Method A	%	ISO 4589-2
Electrical properties (23°C/50% r. h.)				
C	Relative permittivity	100 Hz	-	IEC 60250
C	Relative permittivity	1 MHz	-	IEC 60250
C	Dissipation factor	100 Hz	10 ⁻⁴	IEC 60250
C	Dissipation factor	1 MHz	10 ⁻⁴	IEC 60250
C	Volume resistivity	-	Ohm·m	IEC 60093
C	Surface resistivity	-	Ohm	IEC 60093
C	Electrical strength	1 mm	kV/mm	IEC 60243-1
C	Comparative tracking index CTI	Solution A	Rating	IEC 60112
	Comparative tracking index CTI M	Solution B	Rating	IEC 60112
Other properties (23°C)				
C	Water absorption (Saturation value)	In water at 23°C	%	ISO 62
C	Water absorption (Equilibrium value)	23°C; 50% r.F.	%	ISO 62
C	Density	-	kg/m ³	ISO 1183-1
Material specific properties				
	Refractive index	-	-	ISO 489
	Light transmittance (blue tinted material)	1 mm	%	ISO 13468-2
Processing conditions for test specimens				
C	Injection molding melt temperature	-	°C	ISO 294
C	Injection molding mold temperature	-	°C	ISO 294
C	Injection molding flow front velocity	-	mm/s	ISO 294

Higher-viscosity grades		Easy-flowing grades			Optical grades				
UV-stabilized		Easy release			UV-stabilized, easy release				
1703	1803	1695	1795	1895	1697	1797	1897	2097	
17	10	45	30	18	45	30	18	8	
17	10	46	31	19	46	31	19	8	
0.8	0.85	0.75	0.8	0.85	0.75	0.8	0.85	0.9	
0.8	0.85	0.75	0.8	0.85	0.75	0.8	0.85	0.9	
2400	2400	2400	2400	2450	2400	2400	2450	2450	
70	72	68	71	74	68	71	74	76	
6.8	6.8	6.2	6.6	6.6	6.2	6.6	6.6	6.9	
> 50	> 50	> 50	> 50	> 50	> 50	> 50	> 50	> 50	
N	N	N	N	N	N	N	N	N	
N	N	N	N	N	N	N	N	N	
9.0	8.0	10	9.0	8.0	10	9.0	8.0	6	
9.0	8.0	10	9.0	8.0	10	9.0	8.0	6	
2400	2400	2400	2400	2450	2400	2400	2450	2450	
105	108	100	105	108	100	105	108	110	
120	121	120	124	127	120	124	127	130	
149	159	138	148	158	137	147	1570	172	
161	174	150	161	173	149	160	172	191	
171	184	158	173	183	157	172	182	202	
140	150	140	140	150	140	140	150	150	
130	130	130	130	130	130	130	130	130	
140	150	140	140	150	140	140	150	150	
0.65	0.65	0.65	0.65	0.65	0.65	0.65	0.65	0.65	
0.65	0.65	0.65	0.65	0.65	0.65	0.65	0.65	0.65	
HB	HB	HB	HB	HB	HB	HB	HB	HB	
HB	HB	HB	HB	HB	HB	HB	HB	HB	
25	25	26	26	26	26	26	26	25	
3	2.9	3	3	2.9	3	3	2.9	2.9	
2.9	2.8	2.9	2.9	2.8	2.9	2.9	2.8	2.8	
10	10	10	10	10	10	10	10	10	
80	80	90	90	80	90	90	90	90	
1E15	1E15	1E15	1E15	1E15	1E15	1E15	1E15	1E15	
1E16	1E16	1E16	1E16	1E16	1E16	1E16	1E16	1E16	
35	35	35	35	35	35	35	35	35	
250	450	250	250	250	250	250	250	600	
125	100	125	125	100	125	125	100	100	
0.3	0.3	0.3	0.3	0.3	0.3	0.3	0.3	0.3	
0.12	0.12	0.12	0.12	0.12	0.12	0.12	0.12	0.12	
1170	1150	1180	1170	1150	1180	1170	1150	1130	
1.578	1.573	1.578	1.576	1.573	1.578	1.576	1.573	1.566	
89	89	89	89	89	89	89	89	89	
330	330	330	330	330	330	330	330	330	
100	100	100	100	100	100	100	100	100	
200	200	200	200	200	200	200	200	200	

The manner in which you use and the purpose to which you put and utilize our products, technical assistance and information (whether verbal, written or by way of production evaluations), including any suggested formulations and recommendations, are beyond our control. Therefore, it is imperative that you test our products, technical assistance, information and recommendations to determine to your own satisfaction whether our products, technical assistance and information are suitable for your intended uses and applications. This application-specific analysis must at least include testing to determine suitability from a technical as well as health, safety, and environmental standpoint. Such testing has not necessarily been done by Covestro. Unless we otherwise agree in writing, all products are sold strictly pursuant to the terms of our standard conditions of sale which are available upon request. All information and technical assistance is given without warranty or guarantee and is subject to change without notice. It is expressly understood and agreed that you assume and hereby expressly release us from all liability, in tort, contract or otherwise, incurred in connection with the use of our products, technical assistance, and information. Any statement or recommendation not contained herein is unauthorized and shall not bind us. Nothing herein shall be construed as a recommendation to use any product in conflict with any claim of any patent relative to any material or its use. No license is implied or in fact granted under the claims of any patent.

With respect to health, safety and environment precautions, the relevant Material Safety Data Sheets (MSDS) and product labels must be observed prior to working with our products.

This product is not designated for the manufacture of a medical device or of intermediate products for medical devices¹. [This product is also not designated for food contact², including drinking water, or cosmetic applications. If the intended use of the product is for the manufacture of a medical device or of intermediate products for medical devices, for food contact products or cosmetic applications, Covestro must be contacted in advance to provide its agreement to sell such product for such purpose.] Nonetheless, any determination as to whether a product is appropriate for use in a medical device or intermediate products for medical devices, for food contact products or cosmetic applications must be made solely by the purchaser of the product without relying upon any representations by Covestro.

¹) Please see the "Guidance on Use of Covestro Products in a Medical Application" document.

²) As defined in Commission Regulation (EU) 1935/2004.

Typical value

These values are typical values only. Unless explicitly agreed in written form, they do not constitute a binding material specification or warranted values. Values may be affected by the design of the mold/die, the processing conditions and coloring/pigmentation of the product. Unless specified to the contrary, the property values given have been established on standardized test specimens at room temperature.



Covestro Deutschland AG
Business Unit Polycarbonates
D-51365 Leverkusen
plastics@covestro.com
www.plastics.covestro.com

COV00072203
Edition 2017-07